

PROJECT: \_\_\_\_\_ CATALOG # \_\_\_\_\_ NOTES: \_\_\_\_\_ FIXTURE SCHEDULE: \_\_\_\_\_

# HIGH & LOWBAY | JELLY JARS

## HLRS SERIES - CID2

The **HLRS SERIES** hazardous location family of fixtures is suitable for use in a wide range of indoor and outdoor Class I Division 2 applications. This versatility family of fixtures can be used for ceiling, pendant, wall and surface applications. The compact and low weight luminaires are safe and easy to use in harsh and hazardous locations where flammable or explosive vapors or gases are present. They are an ideal solution where long life and low maintenance are desired.



Shown with clear lens

Shown with drop lens and wire guard

New version coming soon

### FEATURES:

- 3000K, 4000K, 5000K
- Customizable offering with clear, diffused and drop lens option
- Second retention point included standard in the luminaire

### LISTINGS:

- Class I, Division 2, Groups A, B, C, D
- Class II, Division 1, Groups E, F, G
- Class II, Division 2, Groups F, G
- Class III, Division 1
- UL1598A Marine
- UL 8750 LED Safety
- CSA, C22.2 No. 250.0-08, 250.13
- DLC Standard
- 1000 hours Spray Testing
- IK08
- FCC

### MOUNTINGS:

- Pendant/Yoke Mount
- Ceiling/Wall/Stanchion Mount
- Outdoor Yoke/Slipfitter Mount

### VOLTAGE:

- 120-277V and 347-480V options available

### CONSTRUCTION:

- Light weight and compact design
- Die cast aluminum body and impact resistant tempered glass
- Stainless steel exposed fasteners
- High temperature silicone gasketing

### APPLICATION:

- Power Plants / Heavy Industrials
- Storage Facility / Paper Mills
- Wastewater Treatment Plants
- Loading Docks / Platforms / Shipyards
- Chemical Processing Facility
- Petrochemical Processing Facility

### WARRANTY:

5-year standard warranty\* (further details available at [www.maxlite.com/warranties](http://www.maxlite.com/warranties))

\*Product may be eligible for a warranty extension to 10 years, for an additional fee. Contact MaxLite for details.

MODEL SELECTION					
HLRS					
FAMILY	NOMINAL WATTAGE	VOLTAGE	CCT	LENS	MOUNTING OPTIONS
HLRS= Small Size Round, CID2	45= 45W 65= 65W	U= 120-277V H= 347-480V*	[Blank]= 5000K 30= 3000K <sup>1</sup> 40= 4000K <sup>1</sup>	[Blank]= Clear, 110° D= Diffused <sup>1</sup> L= Low Bay Drop Lens, 190°	P= Pendant, 3/4" NPT- Yoke Mount, U-bracket X= Ceiling, Wall & Stanchion Mount Options  <i>Order mounting separately, see Accessories Table below</i>

<sup>1</sup> Consult factory for lead times.

### ORDERING:

MODEL NUMBER	DLC PRODUCT ID	MODEL NUMBER	DLC PRODUCT ID	MODEL NUMBER	DLC PRODUCT ID
HLRS45U[P,X]	PLBDN4JOOYCB	HLRS45UL[P,X]	PXZVYIC8	HLRS45U40[P,X]	PLS10TLJ8KLO
HLRS65U[P,X]	PLCVXQH5E68Q	HLRS65UL[P,X]	PYU2YCX6	HLRS65U40P	PLYELME28QGQ

PROJECT: \_\_\_\_\_ CATALOG # \_\_\_\_\_ NOTES: \_\_\_\_\_ FIXTURE SCHEDULE: \_\_\_\_\_

# HIGH & LOWBAY | JELLY JARS

## HLRS SERIES - CID2

### SPECIFICATIONS:

		HLRS45*	HLRS45*D	HLRS45*L	HLRS65*	HLRS65*D	HLRS65*L
ITEM	SPECIFICATION	DETAILS					
GENERAL PERFORMANCE	Input Power (W)	45W			65W		
	Lumens Delivered (lm)	6,750 lm	5,765 lm	5,760 lm	9,750 lm	8,640 lm	8,960 lm
	Equivalency	100W MH			175W MH		
	Efficacy (lm/W)	150	128	128	150	133	139
	CRI	≥70					
	Lumen Maintenance (L70, TM-21 @ 25°C)	50,000 Hours @ L70					
	Color Temperature	3000K, 4000K, 5000K					
	Spacing Criteria	Available Upon Request					
ELECTRICAL	Power Factor	0.95					
	Input Voltage	120-277V, 347-480V					
PHYSICAL	Housing	Die cast aluminum with powder coat paint					
	Lens Material	Tempered Glass					
	IP Rating	IP66					
	IK Rating	IK08					
QUALIFICATIONS	Ambient Operating Temperature	-40°C - 55°C			-40°C - 55°C (120-277V); -40°C - 52°C (347-480V)		
	Ambient Operating Humidity	5%-95% RH					
	Temperature Code	T4A (C1D2) / T5 (C2D1, C2D2)					
WARRANTY	Warranty	5-year standard warranty*					

\*Based on 5000K and 120-277V

### ACCESSORIES TABLE:



MODEL	DESCRIPTION	PRODUCT IMAGE
HLCMG	Ceiling Mount Bracket (junction box with 3/4" NPT entries). Fits with fixture X mounting option.	
HLS22G	Stanchion 25° (1-1/2 NPT) Mount Bracket. Fits with fixture X mounting option.	

PROJECT: \_\_\_\_\_ CATALOG # \_\_\_\_\_ NOTES: \_\_\_\_\_ FIXTURE SCHEDULE: \_\_\_\_\_

# HIGH & LOWBAY | JELLY JARS

## HLRS SERIES - CID2

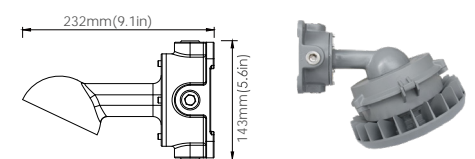
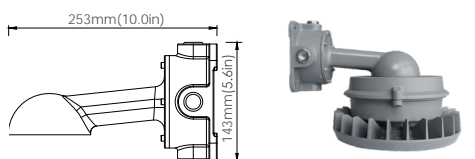
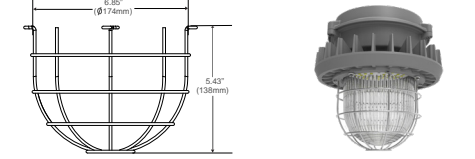
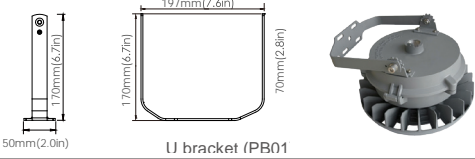
### ACCESSORIES TABLE:

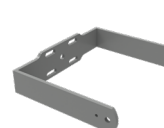
MODEL	DESCRIPTION	PRODUCT IMAGE
HLW25G	Wall Mount 25° Bracket	
HLW90G	Wall Mount 90° Bracket	
HLRSWG	Wire Guard for Drop Lens, Small Size	
HLRSYB	Yoke Bracket, Small Size. Fits with fixture P mounting option, no ANSI vibration rating.	
HL-TA	2-3/8 Inch Tenon Adaptor - Grey Finish **Must order HLRSYB05 with this accessory	
HLRSYB05	HLRS Series, Yoke Bracket, Small Size, Stainless Steel, 5mm. Fits with fixture P mounting option, ANSI 1.5G vibration rated.	

### DIMENSIONS

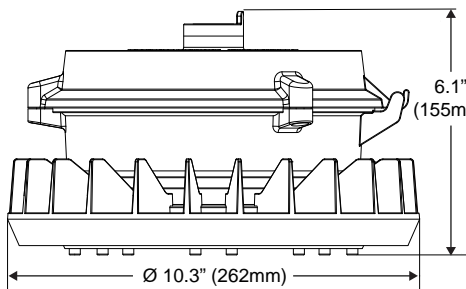

Pendant

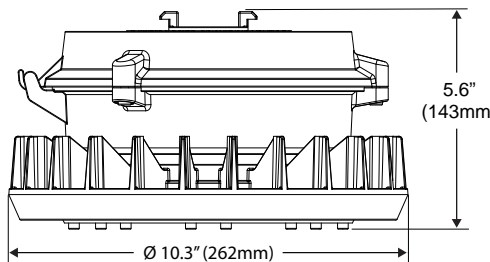

Ceiling, Wall, Stanchion

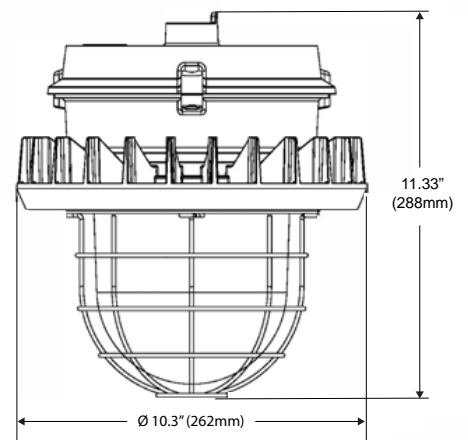

Drop lens & wire Guard